

ATAG

SERVING INDUSTRY SINCE 1947

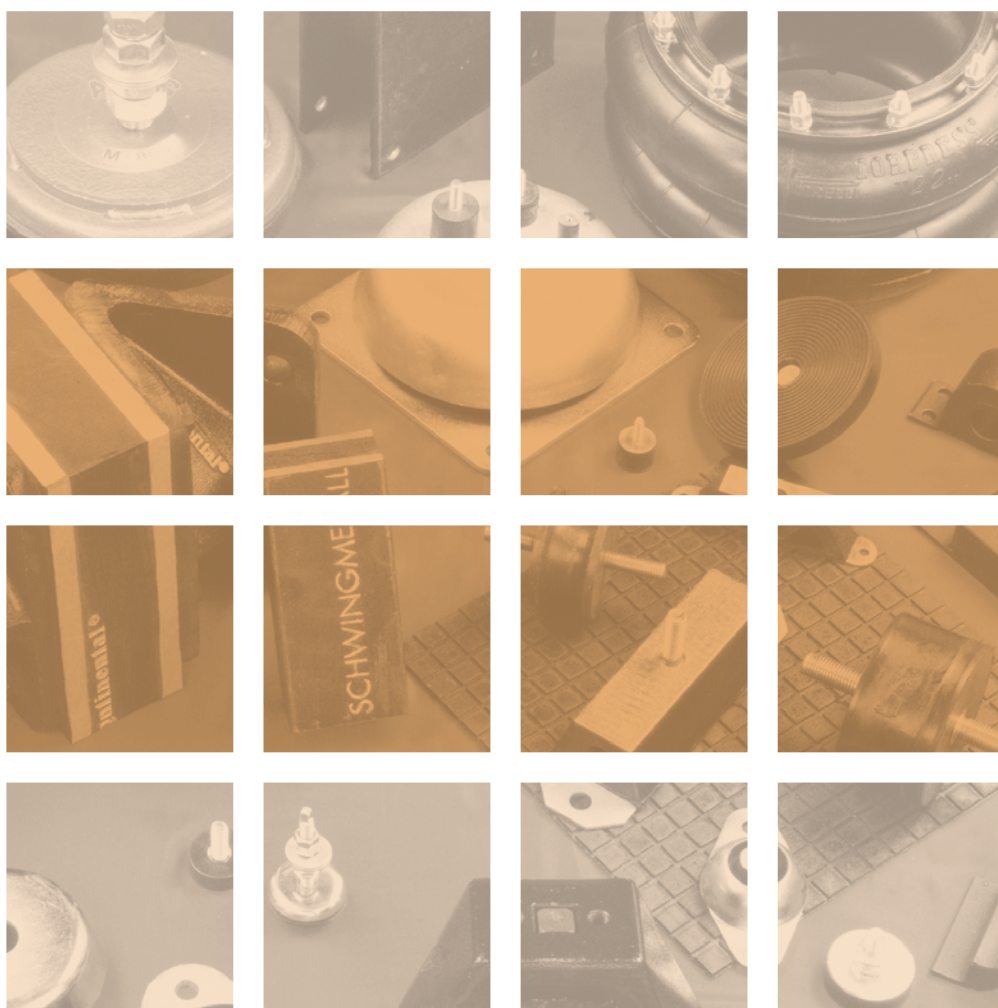

ANTI-VIBRATION

- Cylindrical mounts
- Impact mounts
- Rail strips
- Hydro mounts
- Pneumatic suspensions
- Support systems
- Leveling systems

VIBRATION

Excessive vibration can disperse energy and create unwanted sounds and noise.

The vibration and noise produced by some machinery can permeate through the air and the structures thereby, negatively influencing the functionality of other machines and/or sensitive equipment.

The conscious use of certain products can significantly reduce the effects of these harmful vibrations. This can greatly increase the efficiency of both machinery and operations as well as creating a better working environment by attenuating the noises and stresses that the vibrations can generate.

There are different kind of vibrations:

- There are vibrations due to forces generated from alternative cyclical movements of mechanical equipment.
- There are abrupt jolts caused from impulses or hits
- There are sound waves permeating both through the air and solid bodies

Our extensive range of anti-vibration products can contribute to the reduction or elimination of these effects through either their insulation or active / passive damping properties.

The elastomers used in their production are of a proven quality and the majority of items in our catalogue are produced by market leading companies who guarantee their efficiency and duration.



ANTI-VIBRATION ELEMENTS RANGE

cylindrical mount Puffer		4	air spring Type FD, FS & Torpress		11
railstrip Schienen		5	equipment support Pumaf		12
railstrip U-Shaped		5	equipment support Apama		12
shear mount Control Panels		6	equipment support Comaf		13
dome mount Topfelemente		6	equipment support Sucoma		13
bell mount "Hat" type		7	equipment support Sutuco		14
bell mount "Bell" type		7	support and isolation Tubiso - Drilled Strip		14
dome mount Backhand "W" form		8	support and isolation Pads		15
railstrip Angled Profile		8	equipment support Anti-vibration Feet		16
flange mounts Flanschelemente		9	equipment support Mago adjustable Feet		17
impact mount Buffers		9	elastic joints Giubo joint		18
integrated hydraulic damping Hydromounts		10	technical notes Isolation from Vibration		19

Cylindrical Mount Puffer



C2A0....
2MM0....
type A

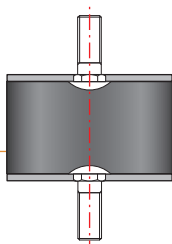

C2B0....
2MF0....
type B

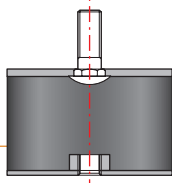

C2C0....
2FF0....
type C

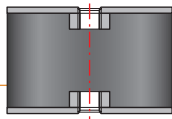

C2D0....
2MG0....
type D

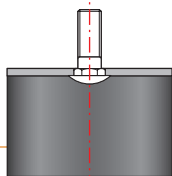

2FG0....
type E

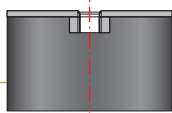

C2DS....
type DS

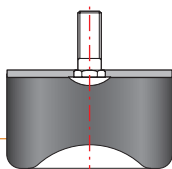

C2AK....
type AK

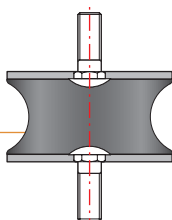

They are extremely versatile supports used in a very wide range of applications: suspension for automotive engines, radiators, instruments, control panels, small motor-compressor and motor generator units, hoppers, measuring devices, electrical panels and small machines in general.

They have a compact cylindrical shape; the elastomer (natural rubber NR) is vulcanized between one or two steel plates equipped with shanks and/or threaded holes for a quick and easy assembly.

They are available in 7 different configurations for fixing depending on the presence of one or two plates and screws or tapped holes. The versions with a single plate are used as disjunction elements between rigid surfaces and tools and small equipment; they work as an anti-vibration foot.

The concave DS version allows a greater immobilization of the machine with a suction effect; the AK version, thanks to its particular shape, allows the anti-vibration to have an elastic mass of different kinds and a proper frequency different from the other puffer; therefore, its behavior differs in response to the vibrations.



railstrip Schienen

C2BA....
type ES_1

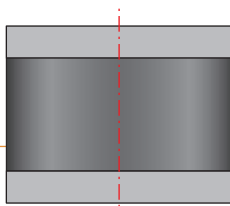

type ES_2

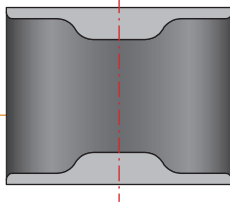

Elastic element consisting of a vulcanized rubber sandwich between two metal rails; suitable for heavy loads.

The bars, usually two meters long, must be used in weighted lengths with calculations based on loads in use. Therefore, they are well suited for use in case of asymmetrical center of gravity.

The metal surfaces must be drilled and threaded for anchoring between parts.

railstrip "U" shaped

C2BU....

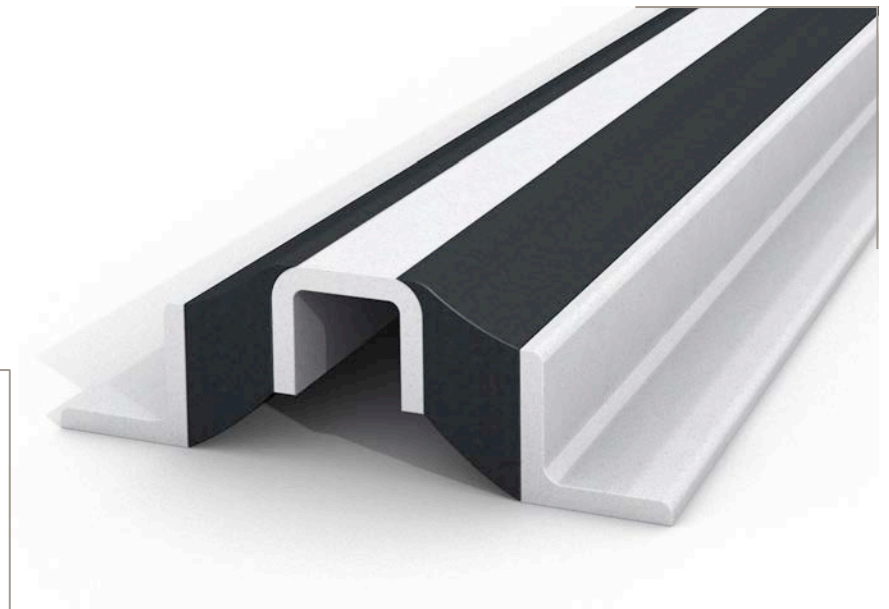
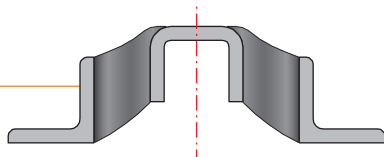

It consists of two rubber elements, bonded to a central metal U-section, and of two L-shaped metal edge sections, that are used for securing the rail strip.

It has a very good lateral stability. It must be used in weighted lengths with calculations based on loads in use and is well suited for use in case of asymmetrical center of gravity.

shear mount Control Panels

C2QS....

item 24332

item 25187

item 21423

item 24284

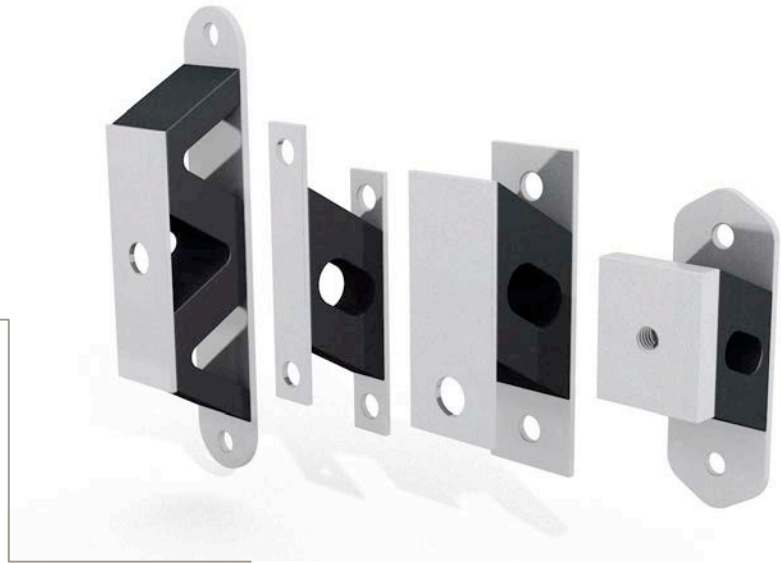
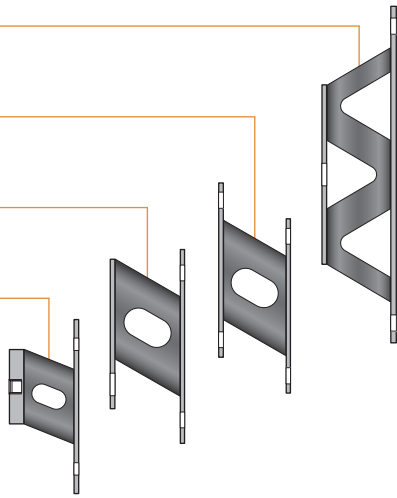

Specifically designed for mounting light masses with low natural frequencies.

They are used to protect sensitive instruments, measuring and displaying equipment, switch cabinets against vibrations.

They are made of a rubber body, cross-sectional pierced in order to obtain an optimum flexibility, vulcanized to upper and lower metal fixing plates.

dome mounts Topfelemente

C2TE....

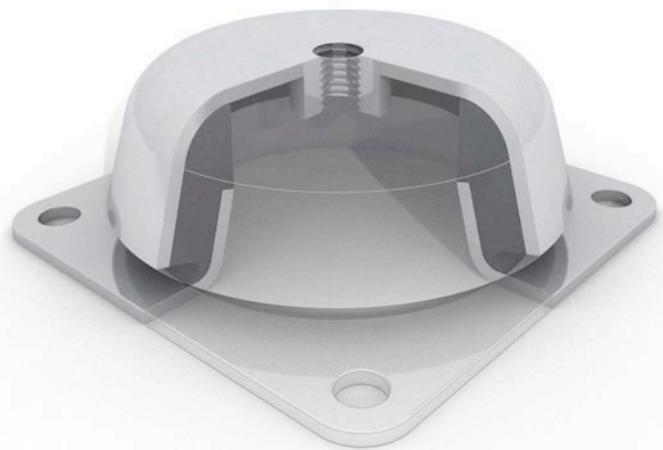
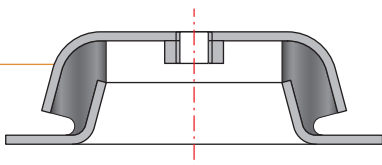

In a good anti-vibration system it is necessary to consider the issue of safety.

The construction of this type of mount allows, in case of accidental breach of the elastic section, the "collapse" of the dome, to which the machinery is fixed, onto the grounded conical section below, therefore securing it.

This prevents the supported machinery from leaving the anchoring point as a result of the vibrating motion or due to the collision that caused the breach of the rubber.

bell mount "Hat" type

C2CA....

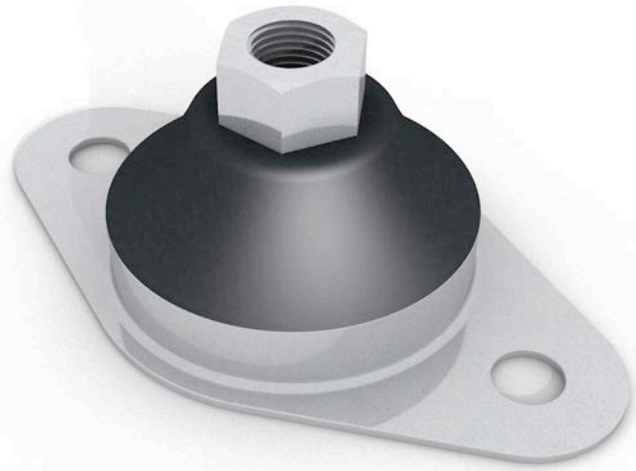
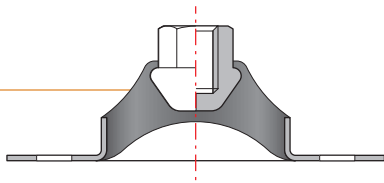

This type of mount is ideal for supporting light / medium loads. It ensures the same stiffness in vertical and lateral directions.

ATTENTION:

Designed to operate only with **compression** and **shear** forces.

bell mount "Bell" type

C2CA....

item 58500

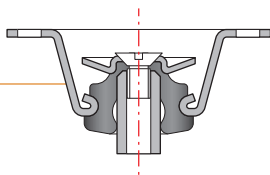

item 27994

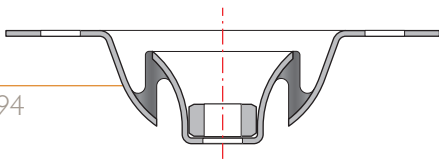

Anti-vibration mount designed specifically for hanging masses.

Suitable for damping hanging loads of up to 70 Kg. Thanks to the particular structure, the tear-off safety function is guaranteed even in case of fire.

ATTENTION:

Designed to operate only with **shear** and **tensile** forces.

dome mount Backhand "W" form

C2WR....
item 38451

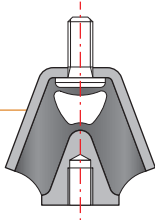

item 33660

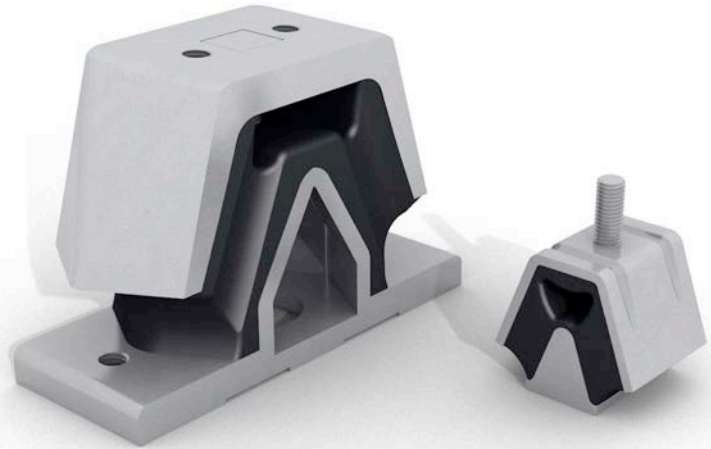
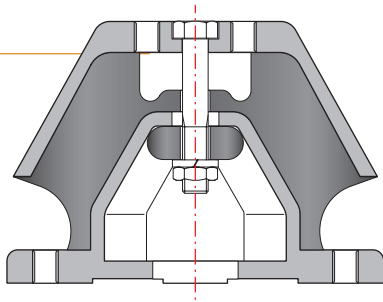

Mount made from an elastic rubber section vulcanized onto an upper metal cap and a base surface, one for securing to the vibrating element, and the other to the fixed anchoring structure.

They are generally installed to maintain vertical static load and can be delivered with tear off safety. The more complex version has a base with two fixing holes.

railstrip Angled Profile

C2BI....

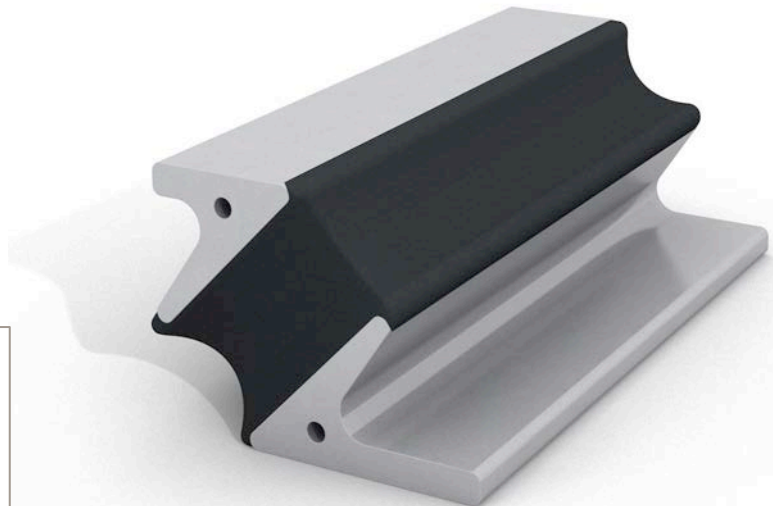
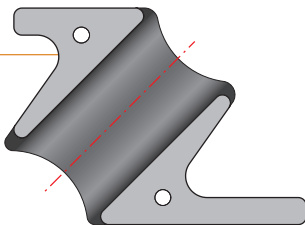

Mounts made from rubber vulcanized to metal supports for fixing the vibrating equipment.

Designed for loads from 100 kg up to 900 kg per part, it can be used in a wide range of mounting combinations of elements of any size, with an easy installation.

Same spring characteristics in both vertical and lateral directions. Very good stability of mounted masses in lateral direction.

flange mounts

Flanschelemente

C2FE....

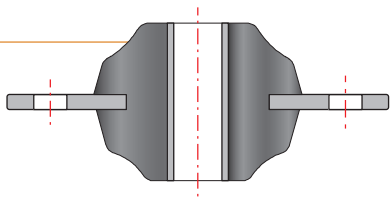

Support with flange for medium loads. Easy to install and resistant; designed for loads from an average of 60 up to 240 kg per single element.

Installation with washers on top and on the bottom guarantees tear off safety (washers not supplied).

impact mount

Buffers

C2P0....

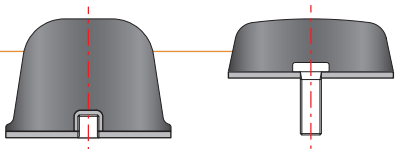

C2PP....

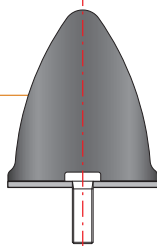

C2BP....

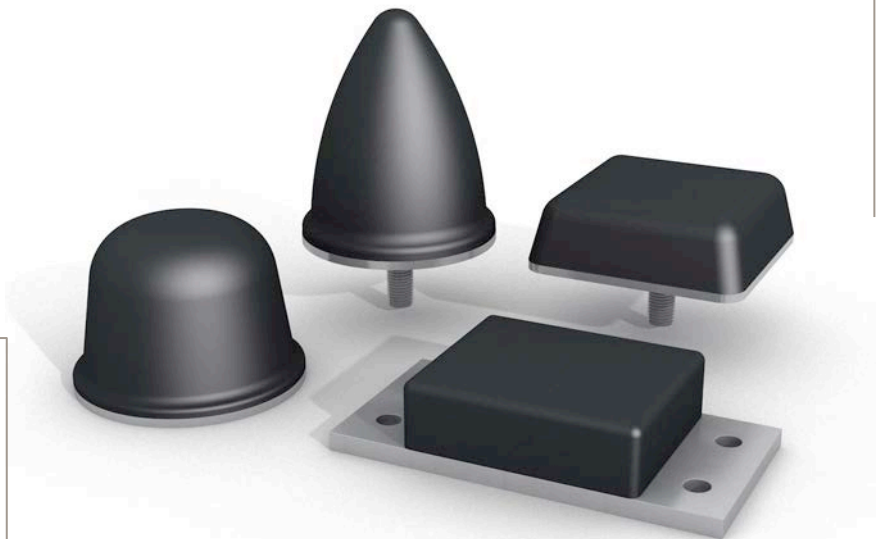
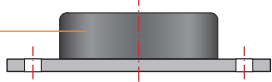

In machinery construction it is often necessary to limit the range of moving parts so to avoid collisions between metal items.

Rubber is the most suitable element for such use, enabling the intentional interruption of such movement by a progressive and silent action.

Rubber pads can have various shapes and dimensions in order to attenuate more or less violent impacts with more or less progressive actions.

integrated hydraulic damping Hydromounts

9AC2HYD....

V series

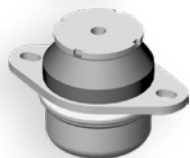
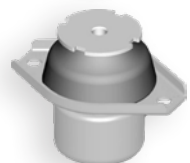
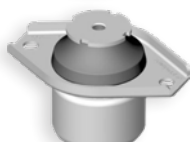
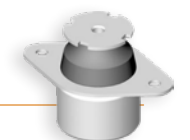

V Plus series

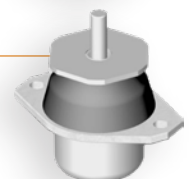

9AC2HYDK....

K series

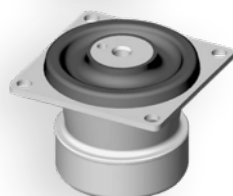
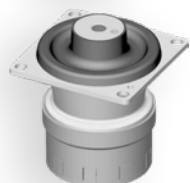
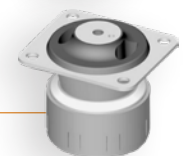

V series

This series is intended for small to medium loads (from 10 to 400 kg) and is ideal when disturbing impulses occur with vibrations, so that a rapid attenuation of the system's vibrations is required (e.g.: engine mounts for industrial vehicles). This is achieved by hydraulic damping.

V Plus series

These hydro mounts offer integrated, broad band damping in the vertical direction and, therefore, are ideal for damping impacts. They feature an integrated rebound stop.

The mounts' principle areas of application include cabin mounting for forklifts, heavy construction machinery, and engine mounts for various industrial vehicles.

K series

With their pronounced transverse rigidity and hydraulic damping in the vertical direction, the sturdy Series K hydro mounts are especially suited for the suspension of medium-sized cabins in construction-sites and agricultural machines.

They are, however, just as well suited for mounting larger engines. Also available as cone mounts (without hydraulic damping).

air spring Type FD, FS & Torpress

**P2FS....
S2TOP....**
Single
convolution

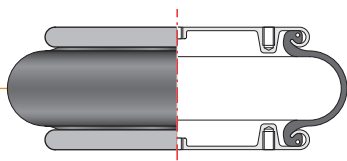

**P2FD....
S2TOP....**
Twin
convolution

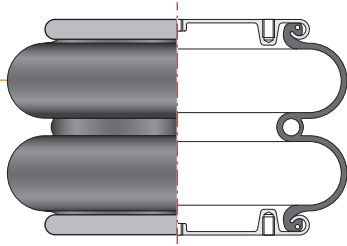

S2TOP....
Triple
convolution

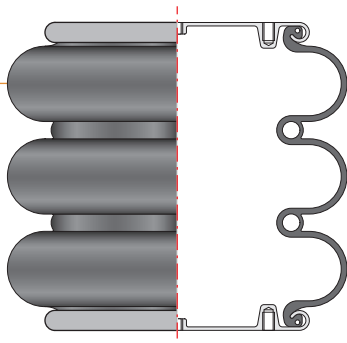

Strong vibration reduction, exceptional longevity and reliability, plus the ability to allow silent and damped control, makes the air spring the ideal product for motor vehicles, trailers and railway carriages.

They guarantee constant stability and levelling of a transported load, as well as oscillation and vibration-free travel, thanks to the possibility to modify their characteristics of flexibility/rigidity and height, according to the variability of their load and the oscillations that it endures during a journey.

These pneumatic suspensions are made of fabric reinforced rubber and function as pressurized air containers.

The rubber covering is sealed at the ends by shaped flanges and/or metallic plates that fix the bellows to the installation and connect the compressed air.

Moreover, they are used in the suspension of fixed systems that must be isolated from external vibration or to protect adjacent areas from machinery vibrations. As simple levelling systems, they allow the maintenance of both a constant height under varying loads and the centre of gravity when increasing loads are involved.

equipment support

Pumaf

S2PUM....

type P

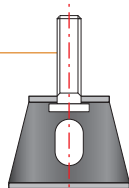

type PP

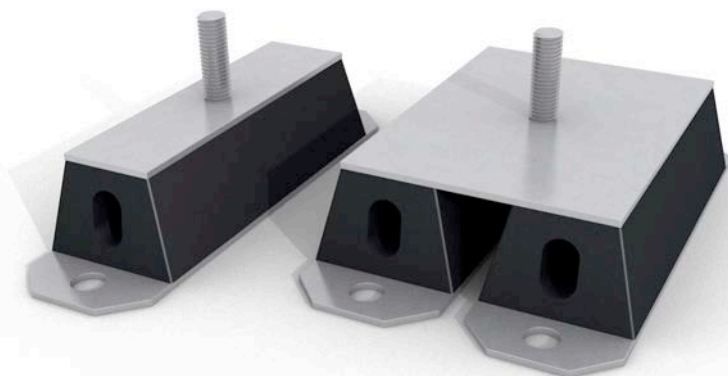
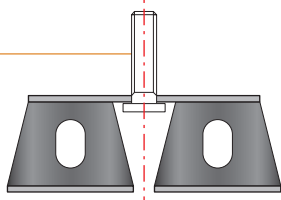

Anti-vibration mounts made of one or two trapezoidal shaped rubber sections pierced longitudinally in order to increase their flexibility.

The rubber sections are vulcanized to a metal cover, that has a bolt for anchoring to the machinery, and to one or two metal base plates for fixing to the ground or to another solid surface.

equipment support

Apama

S2APA....

type A

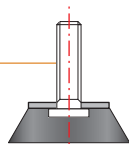

type AA

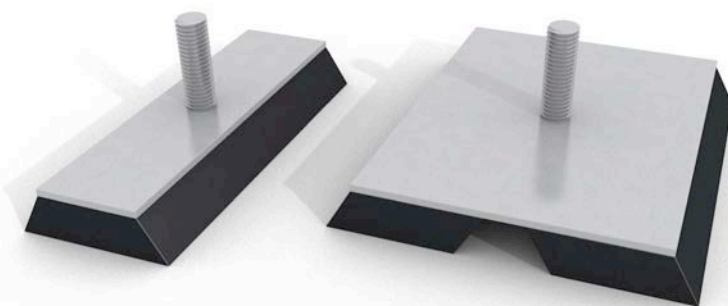
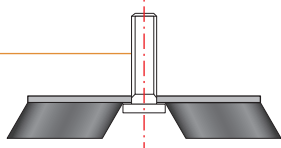

Elastic mounts made of one or two rubber sections vulcanized to a metal cover fitted with a bolt for fixing to machinery.

Adhesion to the ground due to the weight of the machinery.

equipment support

Comaf

S2COM....

type C

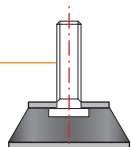

type CC

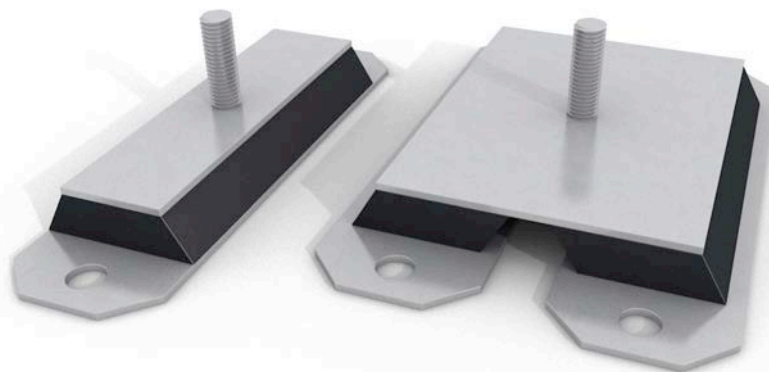
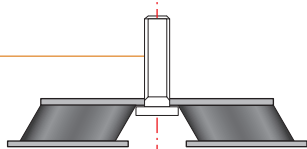

Structurally identical to the APAMA anti-vibration mounts, it differs only for the rubber sections that are vulcanized to a drilled metal baseplate for fixing to the ground.

To be used in the presence of transverse dynamic forces or when the base surface is particularly smooth.

equipment support

Sucoma

S2SUC....

type 1

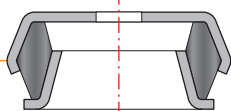

type 2

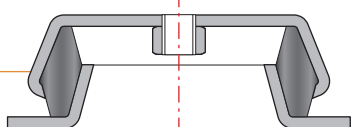

type 3

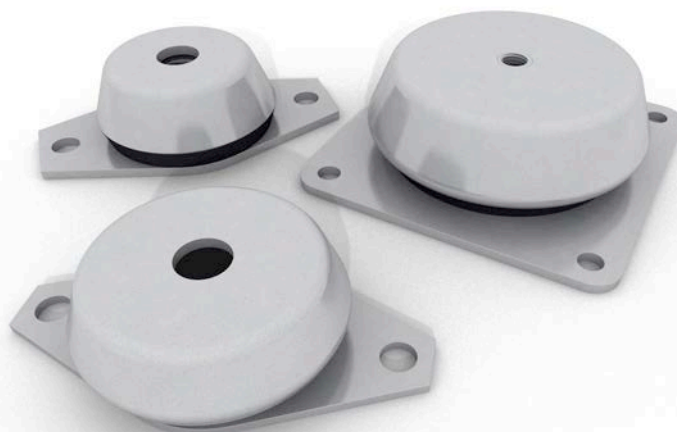
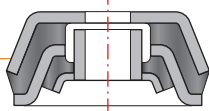

In this mount the rubber is vulcanized, on the upper part, to a metal dome which has a threaded hole for a securing bolt and, at the bottom, to a metal base plate pre-drilled for securing to the floor or to other rigid surface.

equipment support

Sutuco

S2STU....

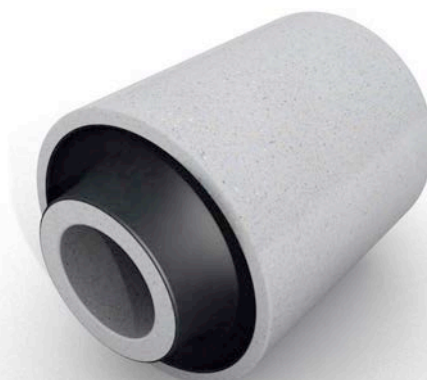
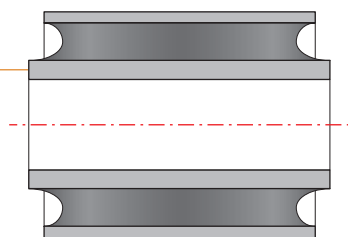

Bushes composed by two concentric metal or plastic sleeves with vulcanized rubber in between.

The vulcanization prevents movements between the outer and the inner sleeves, due to creeping of the rubber.

It can also be used as a simple torsion spring.

support and isolation

Tubiso - Drilled Strip

R2TUB....

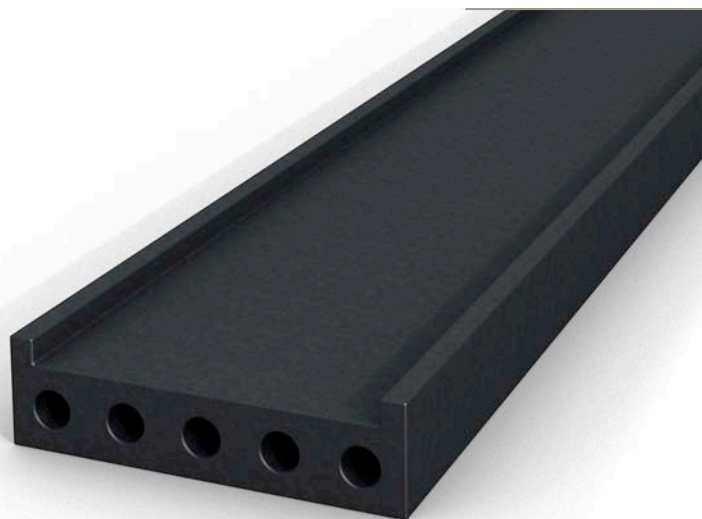

Rubber strip punched longitudinally in order to make it more flexible.

Elastic section for fitting around fluid and gas pipes.

Cut in sections equal to the circumference of the pipe to insulate, it can be mounted between a metal collar and the pipe.

support and isolation Pads

S2PLQ....

Squared Pads

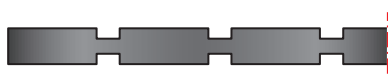

S2MAT....

Matel pads

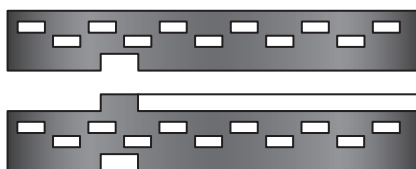

R2PG....

PG pads

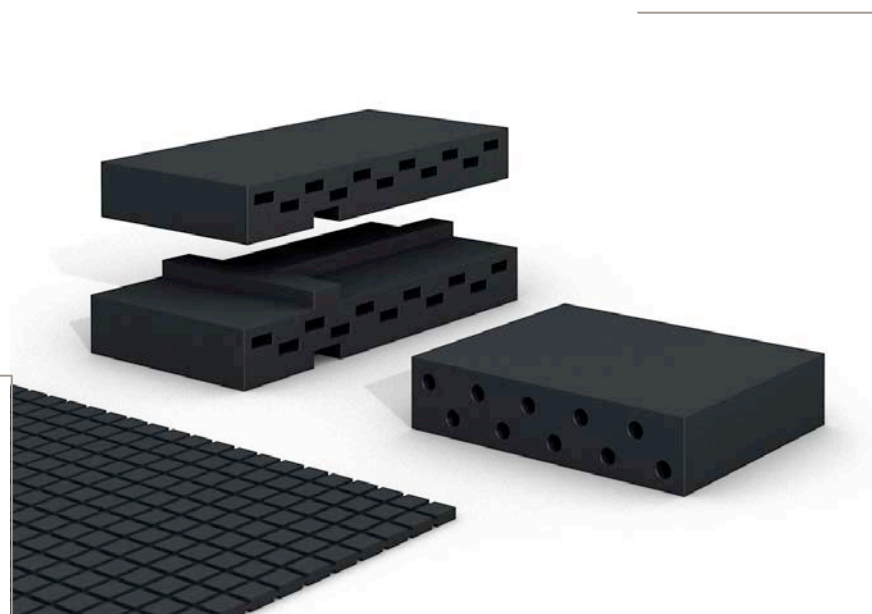

Squared pads

Pads for electronic instruments or machinery in general, they are sensitive to vibrations and have a low weight.

Used in applications where the frequency to be insulated is greater than 40 Hz. The plates are placed directly under the item to be insulated.

Matel pads

Matel pads were developed in order to perform a highly isolation from vibrations; they have a great versatility of use and are easy to install.

They have been mainly designed to solve the problems involving elastic foundations. This particular type of anti-vibration suspensions is used when a machine, together with its motor and transmission, is secured rigidly to an inertial mass, usually reinforced concrete. Matel pads let the entire system rest on well distributed elastic supports so to isolate it.

PG pads

As MATEL pads, they solve the problems of vibration related to the foundations, but they are especially suitable, thanks to their rectangular shape, for being inserted under flat based, or with a wide support surface, machinery.

equipment support Anti-vibration Feet

S2APU....

Apuco feet

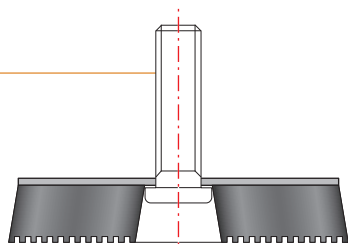

R2L....

R2L feet

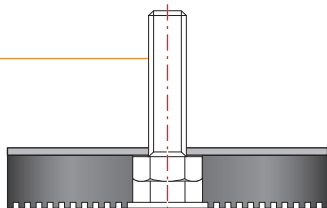

S4VE....

Light Load feet

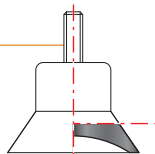

R2PD....

Light Load feet

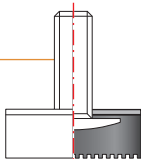

9APM....

feet with 30° Adjustable Bolt

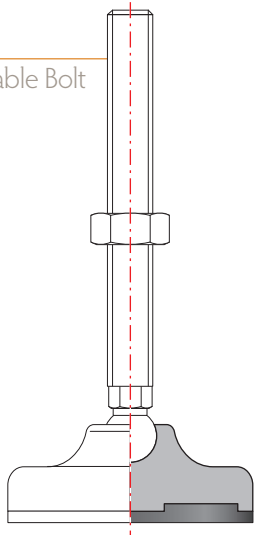

APUCO feet

Anti-vibration feet for machinery based on ground. APUCO are made of rubber sections vulcanized around a circular metal disc with an integral central bolt for fixing the support to the base of the machinery.

R2L feet

R2L feet are made of a rubber section vulcanized to a punched metal disc onto which a bolt is fixed for securing the foot to the machinery body.

Light Load feet

Anti-vibration/anti-slip feet for floor based machinery with medium-high loads. Suitable for equipping tables, washing machines etc. where the system load is not excessive.

These feet are mainly used as support elements; they are made from rubber or PVC that is anchored to a bolt for fixing to the machinery.

Ideal for supporting washing machines and electronic instruments that don't need to be isolated from harmful vibrations.

Feet with 30° Adjustable Bolt

Adjustable plastic feet with pivoted iron bolt for industrial machinery and floating floors.

They are made of fiber glass reinforced polyamide and have a NBR 70 shore anti-slip rubber base. NBR rubber makes them suitable for use in workshops and any other place where there are traces of oil.

The rubber base has an anti-slip function only, it doesn't absorb vibrations. The feet are also designed for fixing to the floor.

equipment support MAGO Adjustable Feet

M2A6....
series M-600

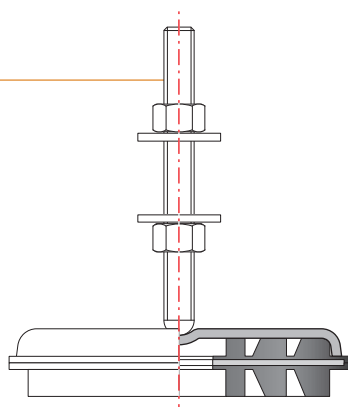

M2A8....
M2AI
series M-800
series M-800 INOX

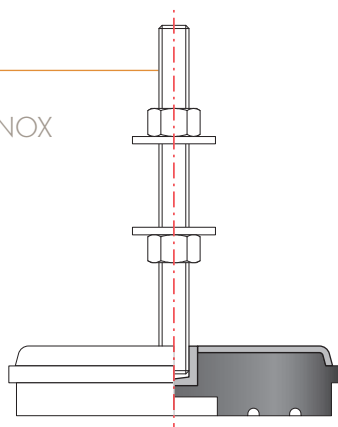

series M-600

Anti-vibration and adjustable feet with a pivoting centre section. They isolate more than 80% of emitted or received machinery vibrations, preserving all moving parts (gears, shafts, etc.) and avoiding rapid wear.

The elastic part, constructed in NITRILE RUBBER, has a good resistance to oils, fats and solvents.

The pivoting mounting bolt with spherical ends fits in the centre of the cap allowing an optimum vibration control on damaged or irregular floors. They are used under ovens, cutters, grinders, plastic materials presses, printing machinery, textile machinery etc.

series M-800

The difference between the M-600 and M-800 series is that the securing bolt in the M-800 series is fixed to the cap, so that the anti-vibration mount remains joined to the machinery also in case it needs to be moved for restructuring, relocation or cleaning: once mounted, it remains fitted to the machinery.

The elastic part of this type is also made of NITRILE RUBBER: it is therefore resistant to oils, fats and solvents.

series M-800 INOX

As the name suggests, this version is entirely made of STAINLESS STEEL and acid resistant NITRILE RUBBER, making it suitable for use in FOOD and PHARMACEUTICAL industries, since they comply with the international hygiene standards, and also for CHEMICAL and NAVAL applications, due to their resistance to chemical and atmospheric agents.

elastic joints

Giubo joint

T2GIU....

Hexagonal version

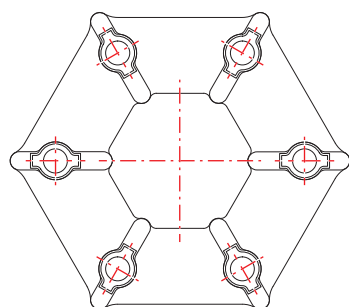
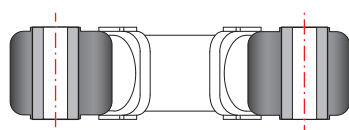

Octagonal version

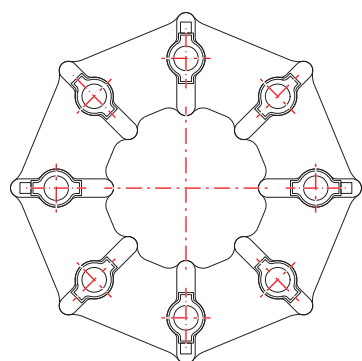
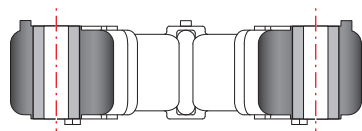

The GIUBO is an elastic joint made of rubber blocks arranged in a polygon. In each apex of the polygon there are metal parts with incorporated holes to allow the connection with drive shafts.

The GIUBO joint must be mounted with the rubber in a pre-compressed condition in order to maintain within limits the traction values generated by the twisting torque, for reasons of security and working life.

For this reason, in the final phase of production, the joints are pre-compressed to the assembly dimensions and maintained in such conditions by a metal clamp around their circumference.

The metal clamp must be cut and removed only after assembly and before operating starts.

technical notes

Isolation from Vibration

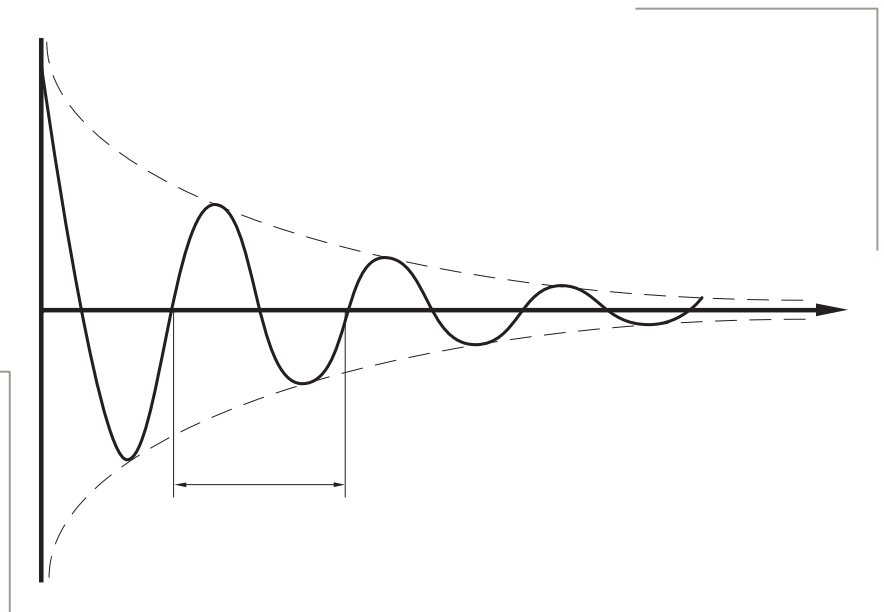

Isolation from vibration is obtained by mounting the items to be isolated (machines / instruments) on soft or elastic materials of a specific hardness. The properties of rubber render it particularly suitable to be used as an elastic material; in fact the most used materials as anti vibration mounts are a combination of rubber and steel.

In comparison with other materials, rubber is very ductile and, thanks to its main property elasticity, has a higher capacity to absorb deformation; thanks to its optimal damping abilities, it plays an important role in reducing noise levels. The issue of acoustics often occurs in the field of vibration absorption.

A good anti-vibration mount is particularly important when machinery, installed over elastic supports, begins to resonate. Their capacity of energy dissipation requires the use of rubber supports like dampers. Their use, however, requires detailed attention. In fact, when the applied load oscillations are elevated, a large quantity of energy is transformed into heat, and this could stress the anti-vibration mounts causing deterioration of the rubber. In this case, there are anti-vibration mounts with metal sections especially developed to guarantee stability between mount and machinery in the event of the rubber failing.

Anti-vibration mounts are placed between the machinery and the support base. In order to be effective, they must be chosen with care, otherwise the result can be considerably compromised.

ATAG anti-vibration mounts are available in various hardness so that the different types of rubber rigidities cover an extremely wide range of applications.

A detailed study of anti-vibration systems would consider all vibration modes by using a stiffness matrix but, in general, the insulation calculation is made for the lowest frequency, because this is the most difficult to isolate; besides that, the most important forces on which to base the calculations are more often the vertical ones. For a careful choice of the correct anti-vibration mount it is necessary to know: forces and disturbing movements together with their relative frequencies, deflection, weights, centre of gravity position, overall dimensions, assembly possibilities, type of machine and any other specific requirements.

ATAG

SERVING INDUSTRY SINCE 1947



IT_20128 MILANO
ph. +39 02 255.22.51
mob. +39 329 68.78.260
ufftec@atag-europe.com

WWW.ATAG-EUROPE.COM